



ART. 112/B

**SERIE CORTA**  
SHORT SERIES  
SERIE COURTE  
KURZE AUSFÜHRUNG

**CLASSIC  
LINE**

ART. 112

**OPTIONAL**

**RUOTE IN NYLON**

Nylon wheels  
Roues en nylon  
Nylonräder



**OPTIONAL**

**TAMPONE IN GOMMA**

Rubber-covered support  
Plateau caoutchouc  
Gummiteller

**ART. 392/A**









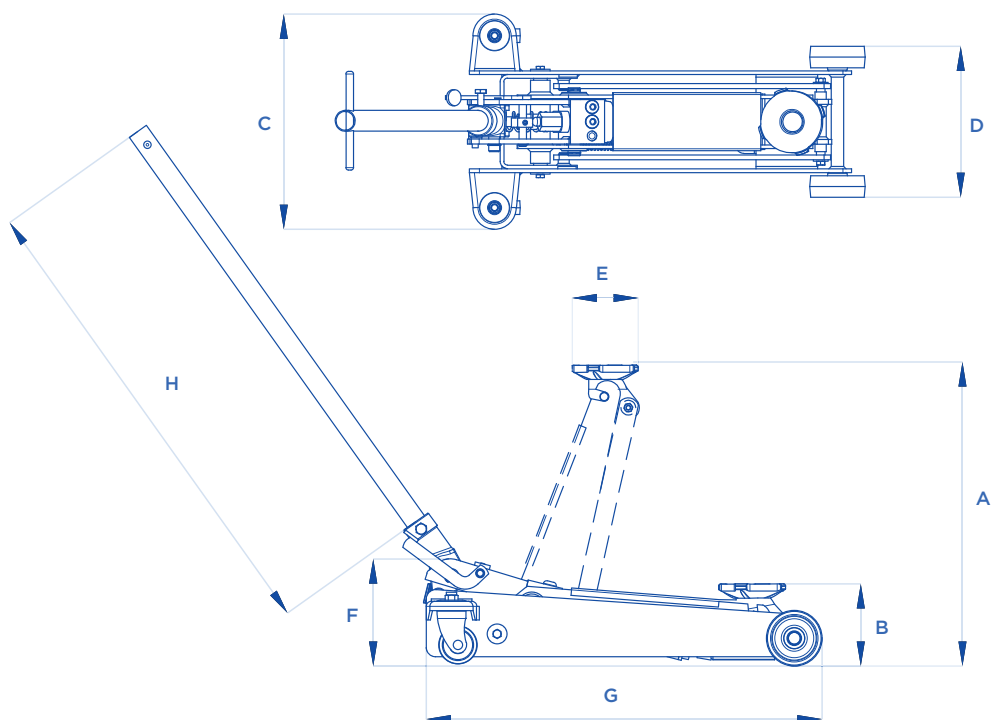

✓ ART. 112 • 112/A

**ART. 392/B**

✓ ART. 112/B • 112/C • 112/D





ART.		 A mm	 B mm	 C mm	 D mm	 E mm	 F mm	 G mm	 H mm	 KG
<b>112</b>	1200 kg	525	130	345	250	100	200	650	780	35
<b>112/A</b>	1500 kg	525	135	345	290	100	200	650	780	36
<b>112/B</b>	2500 kg	610	145	375	310	130	210	760	780	51
<b>112/C</b>	1200 kg	750	145	370	300	130	210	950	780	59
<b>112/D</b>	1500 kg	800	145	370	300	130	210	950	780	60

 Comando di discesa a pedale • Foot descent-control • Commande de descente à pédale • Fußpumpe Kontrolle